



GE25-FW

Spherical plain bearing

Schaeffler ID:
0066500580000

Radial spherical plain bearing, maintenance-free, sliding layer: PTFE composite, inner ring curved surface with hard chromium coating, DIN ISO 12240-1, dimension series G, open design

Technical information

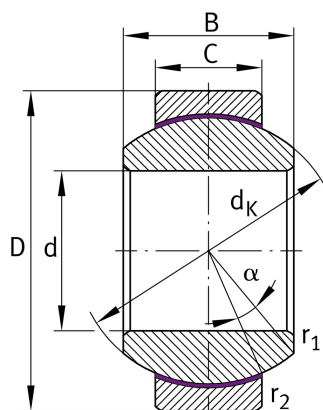
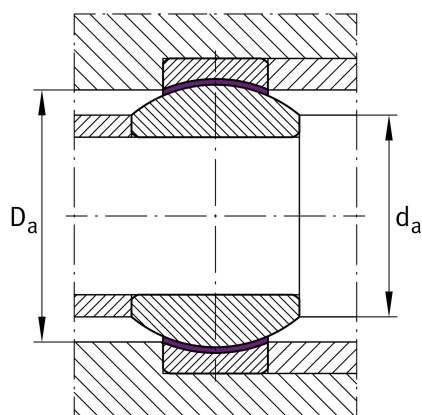

Main Dimensions & Performance Data

D	47 mm	Outside diameter bearing
d	25 mm	Bore diameter bearing
B	28 mm	Width Inner ring
C	18 mm	Width Outer ring
C _r	65,900 N	Basic dynamic load rating, radial
C _{0r}	165,000 N	Basic static load rating, radial
	0.2 kg	Weight

Dimensions

d _K	40.7 mm	Ball diameter
α	17 °	Tilt angle
G _r	0 - 0,05 mm	Radial Clearance
d _{OT}	0 mm	Bore diameter bearing, upper tolerance
d _{UT}	-0.01 mm	Bore diameter bearing, lower tolerance
D _{OT}	0 mm	Outside diameter, upper tolerance
D _{UT}	-0.011 mm	Outside diameter, lower tolerance
B _{OT}	0 mm	Width inner ring, upper tolerance
B _{UT}	-0.12 mm	Width inner ring, lower tolerance
C _{OT}	0 mm	Width outer ring, upper tolerance

Mounting dimensions

r _{1smin}	0.6 mm	Edge Spacing
r _{2smin}	0.6 mm	Edge Spacing
d _{a max}	29.5 mm	Connection measure Inner ring
D _{a min}	38 mm	Housing Connection Diameter

Temperature range

T _{min}	-50 °C	Operating temperature min.
T _{max}	200 °C	Operating temperature max.